

unit: mm

A

B

C

D

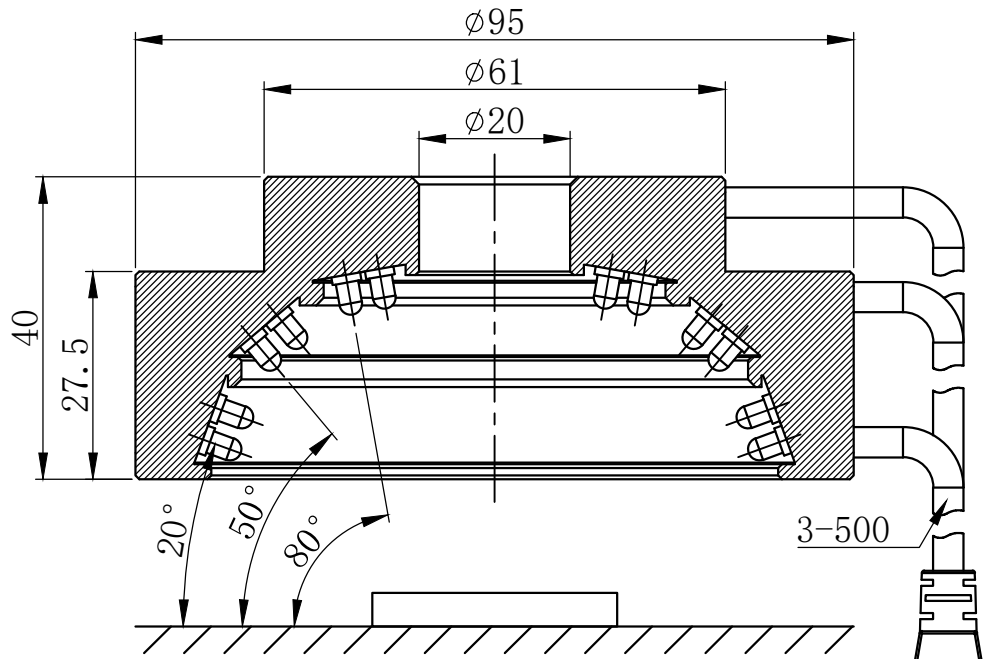

Test object
A-A

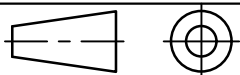
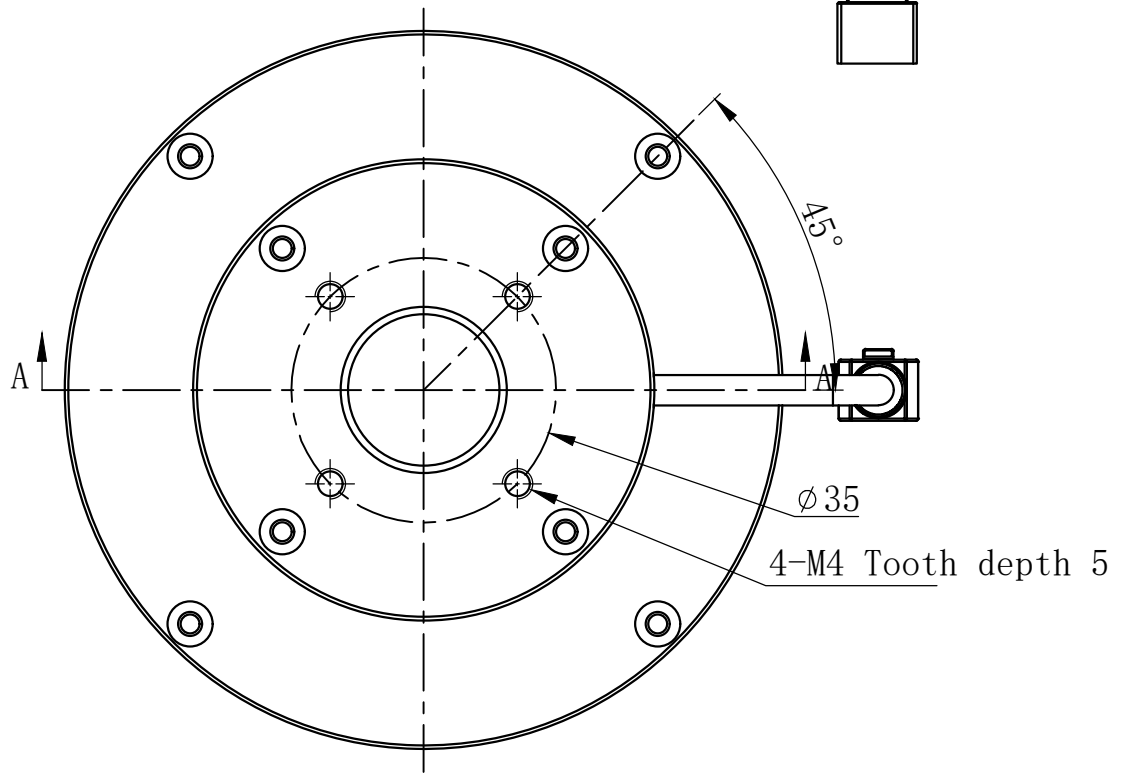

Model AOIL9520

Product installation dimensions

Version number 1.0

Name AOI lights

Proportion 1:1

Date

